

Excited-State Reaction of Short-Lived 2-Methylbenzophenone Enols Studied by Stepwise Two-Color Excitation Time-Resolved Thermal Lensing Technique

Tadashi Suzuki, Takashi Omori, and Tejiro Ichimura*

Department of Chemistry and Materials Science, Tokyo Institute of Technology, Ohokayama, Meguro-ku, Tokyo 152-8551, Japan

Received: April 18, 2000; In Final Form: September 5, 2000

Reaction dynamics on excited states of two kinds of enols (Z and E) for 2-methylbenzophenone (MBP), which are produced through an intramolecular hydrogen abstracting reaction with the 308-nm laser irradiation, has been studied in ethanol solution with stepwise two-color excitation time-resolved thermal lensing (TC-TRTL) and stepwise two-color excitation transient absorption techniques. When the E-enol was solely excited with the 532-nm laser, the increase of the transient absorption was observed at less than 420 nm, while no spectral change appeared for excitation of the Z-enol. It reveals that only the E-enol does react after the excitation to presumably produce dihydroanthrone (DHA). The heat of reaction was successfully determined by the TC-TRTL method, and the reaction was found to occur endothermically. The candidates for the photoproduct were also discussed.

Introduction

The photoinduced enolization process is a very general phenomenon that widely occurs with a variety of substrates.¹ The *o*-alkyl aromatic ketones such as 2-methylbenzophenone (MBP) are well-known as a photoenolizing compound. The reaction mechanism has been studied with the flash photolytic technique,^{2–24} ultrafast spectroscopy,^{25,26} the paramagnetic resonance technique,^{27–31} and supersonic jet spectroscopy.³² Excited MBP undergoes intramolecular hydrogen abstracting reaction to produce two kinds of enols (Z and E) in their ground states via a biradical state, which finally reproduce the parent keto form with different lifetimes (Figure 1). In a previous article, we reported heat of reaction on the photoenolization (E_Z and E_E) in ethanol solution by one-color time-resolved thermal lensing (TRTL) technique for the first time.^{33,34} The E_Z and E_E values were obtained to be 112 and 202 kJ/mol, respectively. The large energy gap (90 kJ/mol) suggests that the E form should be further distorted due to the bulky phenyl group. The heat of formation and molecular volume change on the enolization reaction were also reported with the transient grating technique.³⁵ The energy gap between the E- and Z-enols is likely to be related with the volume of the substituents on the carbonyl group from MBP to 2-methylbenzaldehyde.³⁶

A further complicated reaction producing a long-lived transient as a yellowish color was observed for MBP. Ullman and Huffman³ irradiated MBP in degassed propane-2-ol matrix at -80 °C and observed two kinds of colored transients. Addition of oxygen caused a low yield of anthrone. They suggested that the two transients should be enols and dihydroanthrone (DHA), and the latter should be a photoproduct of enols. Porter and Tchir^{4,5} also observed similar transients during flash photolytic experiments on 2,4-dimethylbenzophenone, 2-isopropylbenzophenone, and 2-benzylbenzophenone. Nakayama et al.²⁶ measured phosphorescence and its excitation

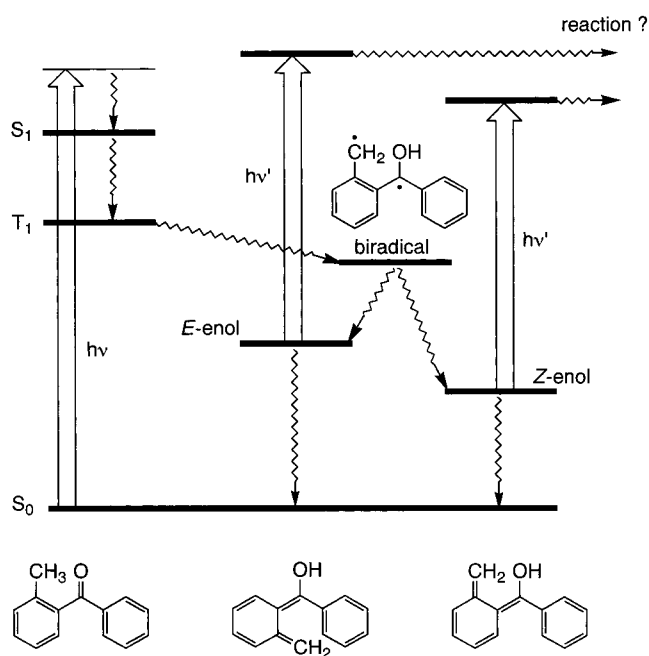

Figure 1. Energy diagram of MBP. Excited MBP undergoes intramolecular hydrogen abstraction to yield Z- and E-enols through a biradical state. Two enols finally reproduce the parent ketone with different lifetimes.

spectra after steady-state photolysis of MBP or E-enol in the rigid matrix at 77 K. They proposed that DHA was produced through excited E-enol. However, some questions remain on the reaction for the DHA production: do the two enols both react when irradiated, and at which energy does reaction channel open?

The time-resolved thermal lensing (TRTL) technique, one of the photothermal methods, is a useful tool for study on non-radiative processes of reaction and/or relaxation pathways because it directly detects heat accompanied with those proc-

* Author to whom correspondence should be addressed. E-mail: tichimur@chem.titech.ac.jp.

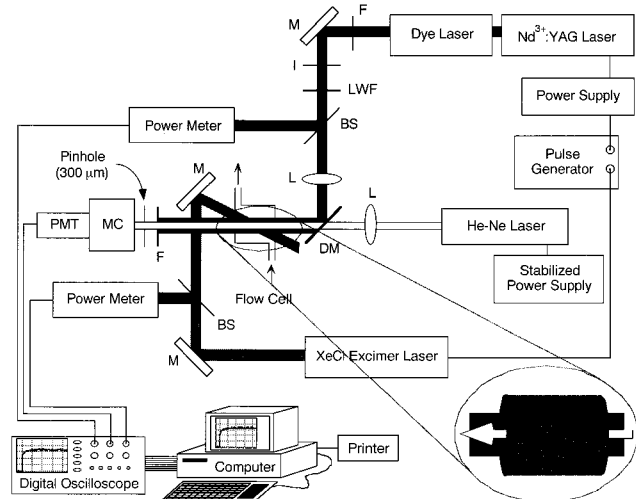

Figure 2. Experimental setup for TC-TRTL measurement. A XeCl excimer laser was used as a photolysis light to produce the enols, and a dye laser pumped by a Nd^{3+} :YAG laser was an excitation light source for the enols. The inset shows the geometry for three laser beams. M, DM, L, BS, F, LWF, I, MC, and PMT are mirror, dichroic mirror, lens, beam splitter, filter, linear wedge filter, iris, monochromator, and photomultiplier tube, respectively.

esses.³⁷ Almost all of the aromatic molecules in the highly excited states (S_n or T_n) are nonfluorescent, obeying the laws of Kasha and Vavilov.³⁸ Detection of heat will give us an important information on dynamics and energetics. The photothermal technique has been applied to the study on relaxation and reaction dynamics in highly excited states.^{39–45} Triplet–triplet absorption spectrum of anthracene was reported, and the evidence of energy transfer from the higher excited triplet state was also shown for the 2-acetylphenanthrene/biphenyl system.^{39,40} Highly excited naphthalene (S_n) in solution generated with two-photon absorption of the 308-nm laser light relaxes into the ground state without fluorescence.⁴¹ The relaxation process of highly excited naphthalene was attributed to quite rapid internal conversion accelerated due to high excess energy through extremely vibrationally hot S_1 state ($S_n \rightarrow S_1^{**} \rightarrow S_0^{***}$), competing with the solvent cooling. Highly excited triplet benzophenone dissociates into two phenyl groups and a carbon mono-oxide molecule.^{42–44} Benzophenone ketyl radical was reported to release a hydrogen atom of the hydroxyl group in the excited state, and the O–H bond energy was only 28 kcal/mol.⁴⁵

Stepwise two-color excitation TRTL (TC-TRTL) technique detects the heat released with the excitation of the transient species which is produced by the photolysis laser irradiation. The TC-TRTL is a useful tool for study on the reaction and/or relaxation dynamics on the transient species in the excited state. In this article, first the stepwise two-color excitation transient absorption method will be used to study reaction dynamics on the excited enols, furthermore, the TC-TRTL technique developed will be applied to the determination of heat of reaction. The candidates for the reaction product will be also discussed.

Experimental Section

The experimental setup for TC-TRTL is described in Figure 2. A XeCl excimer laser (Lumonics TE-860-4: 10-ns pulse duration, 110 mJ/pulse) was used as a photolysis light to produce enols, which were excited with a dye laser (Molelectron DL223: stilbene3) pumped by a frequency tripled Nd^{3+} :YAG laser (Quantel Brilliant ω : 70 mJ/pulse at 355 nm, 5-ns pulse duration). The two lasers were controlled with a handmade pulse

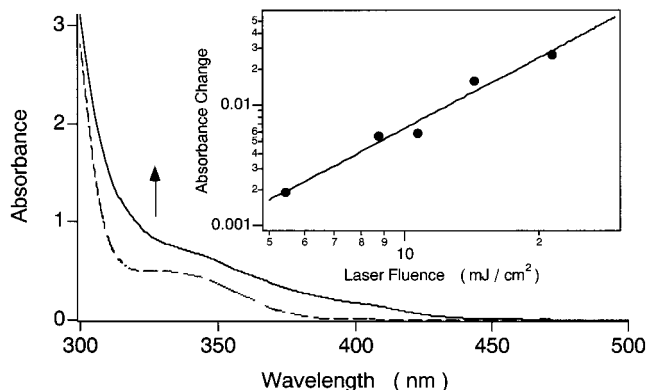

Figure 3. Absorption spectra of MBP in ethanol with (solid line) and without (broken line) the 308-nm laser irradiation of three hundred laser shots under the highly photon fluence. A new absorption band appeared between 300 and 450 nm. The absorbance change monitored at 390 nm was plotted against the laser photon fluence shown in the inset. The slope was determined to be 2.0 ± 0.2 .

generator, and synchronously fired. A He–Ne laser (Uniphase 1103P: 2 mW) with a stabilized power supply (Takasago: ARH500) was used as an analyzing beam for the thermal lens. The photolysis light was irradiated widely as including the excitation and probe beams as shown in the inset of Figure 2 in order to get a good S/N ratio and to avoid the contamination of the heat due to the photolysis light irradiation. The excitation laser power was attenuated with a variable neutral density filter (Corion 2161) and monitored with a silicon photodiode (Hamamatsu S1336-5BQ) calibrated with a pyroelectric detector (Gentech ED100). The excitation beam was focused into a sample cuvette (NSG T-59FL-10: 10-mm light path length) with a 150-mm focal length lens collinear to the probe beam, which was focused with a 30-mm focal length lens in front of the cuvette. The analyzing beam sampled through a pinhole (Corion 2401: 300- μm diameter) and a monochromator (Jasco CT-10: 0.5 nm resolution) was detected with a photomultiplier tube (Hamamatsu R928). The output signals were converted into voltage with a 500- Ω load register, measured by a digital oscilloscope (Sony Tektronix TDS-380P: 2 GS/s, 400 MHz), and transferred to a personal computer.

Transient absorption spectra were measured with the conventional laser flash photolysis system consisting of the excimer laser and a steady-state Xe lamp (Ushio UXL-300DO: 300 W). The stepwise two-color excitation transient absorption measurements were carried out with the excimer laser as a photolysis light and the frequency doubled Nd^{3+} :YAG laser (532 nm) as a excitation light for the enols. To obtain the emission spectra for the enols, stepwise two-color laser excitation fluorescence measurement was also performed with the same setup as the two-color transient absorption measurement except the Xe lamp.

Absorption spectra were measured with a double-beam spectrophotometer (Jasco V550). MBP (Tokyo Kasei: GR grade) was purified by distillation. Ethanol (Tokyo Kasei: GR grade) was used from a freshly opened bottle. All sample solutions were deaerated by bubbling Ar gas (Purity 99.95%) purged by solvent vapor for half an hour before use. All measurements were carried out at room temperature.

Results and Discussion

1. Two-Color Excitation Transient Absorption Measurements. Figure 3 shows absorption spectra of MBP in ethanol measured before (broken line) and after (solid line) several thousand shots of the 308-nm laser under the high photon flux

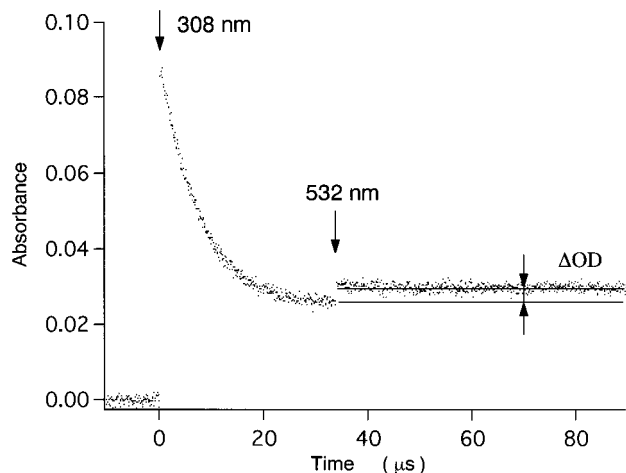

Figure 4. Time profile of stepwise two-color laser excitation transient absorption of MBP in ethanol monitored at 370 nm. The E-enol is solely excited with the 532 nm laser at 35 μs after the 308-nm excitation, and increase of absorbance was apparently observed.

condition. A new absorption band clearly appears in the spectral range less than 450 nm. The amount of the absorption increase monitored at 390 nm is proportional to the second order of the photon flux irradiated as shown in the inset of Figure 3. Since the slope was determined to be 2.0 ± 0.2 , the product should be formed due to the two-photon. The absorption changed gradually returns as time passed and finally became as it was before. The new absorption band well agrees to the reported spectrum of dihydroanthrone (DHA),³⁻⁵ which would have been considered to be formed with the enols being excited as shown in the Introduction section.

Transient absorption spectra of MBP in ethanol were measured. The spectra whose peaks appeared at around 400 nm, well agree with the one reported for the enols.^{3-5,25,26} The spectral features of the enols are similar to each other. The time profile of the transient absorption monitored at 400 nm shows two decay components. The best-fit curve was obtained with the biexponential decay equation. The fast (4.2 μs) and slow ones (6.8 ms) should be attributed to the Z- and E-enols, respectively, whose lifetimes well agree with the values reported previously.^{26,33}

The stepwise two-color excitation transient absorption measurement was performed to obtain information on the reactivity of the excited enols. Figure 4 shows the time profile of transient absorption monitored at 370 nm with the irradiation of the 532-nm laser at 35 μs after the photolysis laser of 308 nm. The increase of absorbance clearly observed after the 532-nm laser irradiation does not recover in several ten milliseconds measured. The rise of absorbance occurs within a laser pulse of 532 nm. The amount of the absorption increase is not affected by oxygen under the aerated condition. Since all the Z-enol returns to the parent ketone within a time of 35 μs , only the E-enol can be excited by the 532-nm laser. Hence, the increase of absorbance should be attributed to a product formed due to photoreaction of the E-enol. The transient absorption spectra before and after the 532-nm laser irradiation are shown in Figure 5. The difference spectrum obtained by comparing the two spectra is also presented. The increase of the absorbance after the 532-nm laser was apparently observed less than 420 nm while the photobleaching was longer than 420 nm. The ΔOD is described as $\Delta\text{OD} = (\epsilon_r - \epsilon_E)[R]d$, where ϵ_r and ϵ_E are extinction coefficients of the product and the E-enol, respectively, $[R]$ is concentration of the product, and d is the optical path length. These results suggest that the photoproduct should

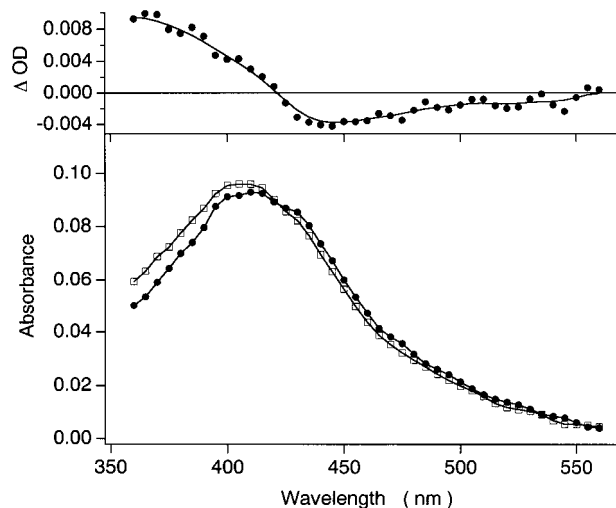

Figure 5. Stepwise two-color excitation transient absorption spectra of MBP in ethanol before (●) and after (□) the 532-nm laser irradiation. The absorption increases after the irradiation below 420 nm while it decreased above 420 nm. The difference spectrum is also presented.

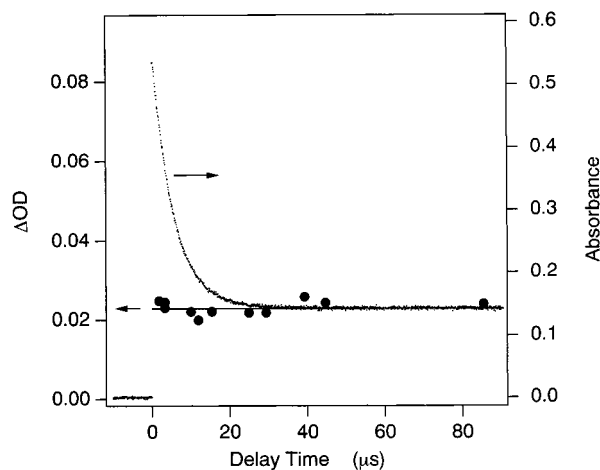

Figure 6. Absorbance change (ΔOD) against the delay time between the photolysis light and excitation lasers monitored at 370 nm. The ΔOD value is almost constant in this time window, which corresponds to the lifetime of the E-enol. The time profile of transient absorption monitored at 370 nm is also shown.

have a slightly larger extinction coefficient below 420 nm than that of the E-enol, and is excellently identical to the absorption spectrum change in Figure 3.

Figure 6 denotes absorbance change (ΔOD) monitored at 370 nm against the time interval between the photolysis and excitation lasers. The time evolution of transient absorption monitored at 370 nm is superimposed upon the time profile. The ΔOD value observed is almost constant within a time range of 85 μs measured. When both enols are excited ($< \text{ca. } 20 \mu\text{s}$) at 532 nm, the amount of the absorption increase does not change, *namely*, it depends on concentration of the E-enol. It reveals that the reaction should be attributed to the E-enol, not to the Z-enol. The photoproduct formed within a laser pulse was found to have a rather long lifetime ($>$ several ten milliseconds). The difference of the reactivity between the two isomers was also observed on the photoexcitation of cis- and trans-stilbenes (*vide infra*).

2. Determination of Heat of Reaction with TC-TRTL Measurements. A thermal refractive index gradient is formed by the heat gradient due to nonradiative processes of excited transients generated with absorption of the excitation laser after

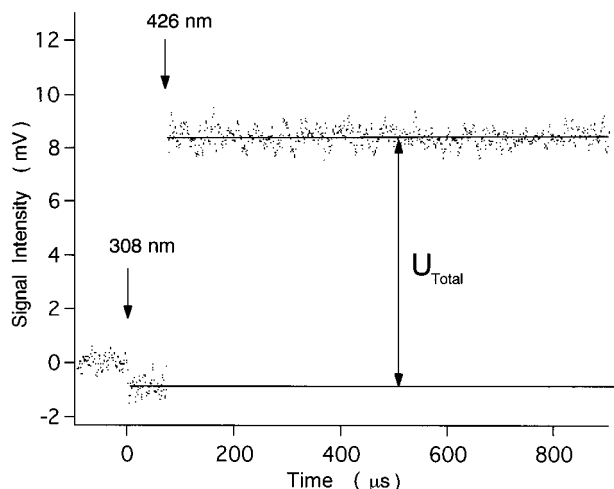

Figure 7. Typical TC-TRTL signal for MBP in ethanol. An excitation laser (426 nm) was fired at 75 μs after the photolysis laser (308 nm). The lens signal rises steeply and becomes a plateau. The signal intensity before and after the excitation pulse was used as a total heat, U_{total} .

the photolysis laser irradiation. The TC-TRTL measurement detects the gradient as a thermal lens signal by He-Ne laser probing. To avoid contamination of the lens signal due to the photolysis laser, the laser beam was widely irradiated into the sample as including both the excitation and probe beams. Under the present experimental condition, the thermal lens signal resulting from the photolysis laser irradiation does not appear, because the temperature increases homogeneously even if slow reaction takes place. The TC-TRTL signal for MBP in ethanol observed is shown in Figure 7. An excitation laser (426 nm) was fired at 75 μs after the photolysis laser (308 nm). The lens signal steeply rises immediately after irradiation of the excitation laser and became plateau. The sharp rise indicates that all relaxation and reaction processes should be completed within the time resolution of our TRTL measurement (300 ns). One thing to note here is that the lens signal did not appear when only one laser was irradiated. However, it appears that the 308-nm pulse gives a weak negative signal. It would be due to inhomogeneity of the photolysis laser beam pattern. Therefore, the signal intensity (U_{total}) before and after the excitation pulse should be regarded as the heat released through nonradiative and reaction processes of the excited E-enol (U_{E}).

The TRTL signal intensity (U_{total}) is proportional to the overall heat released and written down as³⁷

$$U_{\text{total}} = K\alpha I_L(1-10^{-\text{OD}}) \quad (1)$$

where K is an instrumental factor including thermal properties of the solvent, I_L the laser energy, OD the absorbance of the sample at 426 nm, and α is the heat conversion efficiency, namely, the fraction of the energy released as heat against the energy absorbed. The lens signal of the E-enol was measured with varying the excitation laser power at various absorbances of the E-enol in order to obtain the α value. Figure 8 shows the laser power dependence of U_{E} . The concentration of enols was controlled with photolysis laser intensity being varied, and monitored by the transient absorption. The occurrence of multiphoton processes were easily detectable in the TRTL measurements.³⁹⁻⁴² Good linear relations were maintained in the laser energy region below 40 μJ , revealing that no multiphoton processes would take place. The slopes of the straight lines in Figure 8, U_{E}/I_L , were plotted against absorptivity, $1-10^{-\text{OD}}$, as shown in Figure 9. A good linear relation was

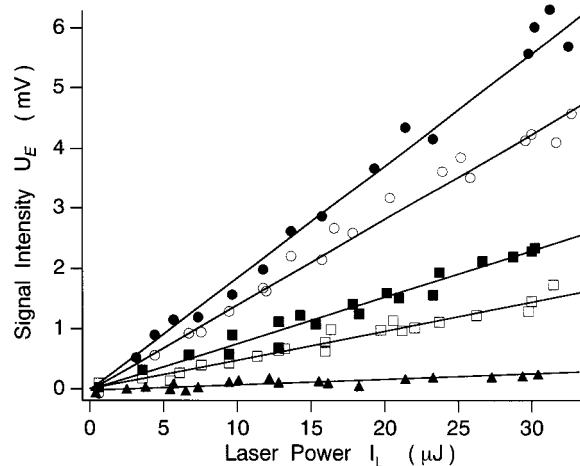

Figure 8. Laser power dependence of U_{E} . The absorbances monitored at 426 nm are 0.0293 (●), 0.0215 (○), 0.0163 (■), 0.0110 (□), and 0.0040 (▲). Good linear relations are maintained in the laser energy region below 40 μJ .

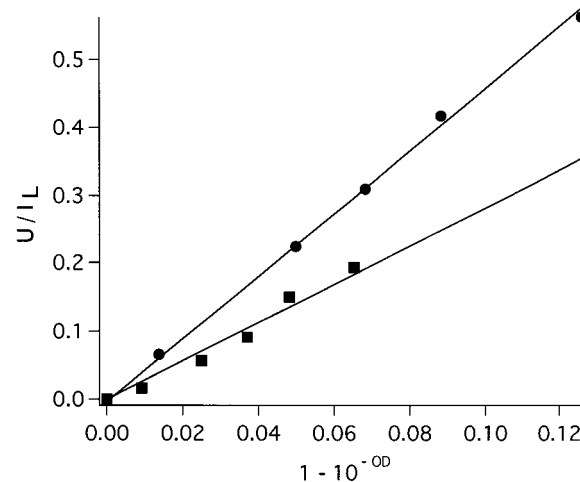

Figure 9. The U_{E}/I_L values vs absorptivity, $1-10^{-\text{OD}}$, for the Z- (●) and E-enols (■).

found between U_{E}/I_L and absorptivity. The solid line was obtained with least squares method. When both enols are excited the heat resulting from the excited Z-enol (U_{Z}) is regarded as the one subtracted the U_{E} value from the total heat (U_{total}) because the TRTL signal appears to be an additive property.³⁷ Equation 1 can be modified as

$$U_{\text{total}} = U_{\text{Z}} + U_{\text{E}} \\ = K\{\alpha_{\text{Z}}I_L(1-10^{-\text{OD}(\text{Z})}) + \alpha_{\text{E}}I_L(1-10^{-\text{OD}(\text{E})})\} \quad (2)$$

where α_{Z} and α_{E} are the heat conversion efficiencies, and OD(Z) and OD(E) are the time-dependent absorbances for the Z- and E-enols, respectively. The plots of U_{Z} vs absorptivity were obtained for the Z-enol in the same manner as the E-enol described above. A good linear relation for the Z-enol between U_{Z}/I_L vs absorptivity was also observed in Figure 9. Since the slopes of the two lines are proportional to each of the α values, the difference of the slopes between two enols reveals that the E-enol should have a smaller α value than the Z-enol. In other words, the excited E-enol should have energy-storing and/or -emitting processes.

Generally, in the case of fluorescing and reaction-active species the α value can be rewritten down with the energy

balance consideration as

$$\alpha = (E_{\text{ex}} - \Phi_{\text{r}}E_{\text{r}} - \Phi_{\text{f}}E_{\text{S}})/E_{\text{ex}} \quad (3)$$

where E_{ex} , E_{S} , and E_{r} are energy for excitation, an emitting state, and heat of reaction, Φ_{f} and Φ_{r} are quantum yields of fluorescence and reaction. The term of $\Phi_{\text{f}}E_{\text{S}}$ on the right-hand should be dropped for no emitting species. Consequently, the product $\Phi_{\text{r}}E_{\text{r}}$ is obtained from the evaluation of α by measuring the ratio of the heat evolved by the sample to that evolved by a calorimetric reference. No emission band was observed for the two enols by the stepwise two-color laser excitation fluorescence measurement ($\Phi_{\text{f}} < 0.01$). There was no emission band observed even in the 77 K rigid matrix.²⁶ Therefore, the assumption of $\Phi_{\text{f}}E_{\text{S}} = 0$ should be valid for both enols. Spectral change, such as absorption increase and/or photobleaching occurring upon the excitation of the E-enol shown in Figures 5 and 6, was not observed for the Z-enol, i.e., $\Phi_{\text{r}}E_{\text{r}} = 0$. Hence, the excited Z-enol would be regarded as a calorimetric standard ($\alpha_{\text{Z}} = 1$). The α value for the E-enol was successfully estimated to be 0.68 ± 0.08 by comparing the two slopes in Figure 9. Using eq 3 and $E_{\text{ex}} = 280$ kJ/mol (426 nm), the product $\Phi_{\text{r}}E_{\text{r}}$ value for the E-enol was determined to be 90 ± 10 kJ/mol. Considering the limitation of the quantum yield ($0 \leq \Phi_{\text{r}} \leq 1$) will let us know that $E_{\text{r}} \geq 90$ kJ/mol. It is concluded that the E-enol should undergo an endothermic reaction upon the photoexcitation while the excited Z-enol should relax into the ground state without any reactions.

3. Reaction Pathway and Candidates for the Reaction Product. MBP absorbs two photons of the 308-nm laser to produce a yellowish photoproduct, which has the absorption band at less than 450 nm (Figure 3). There are some possible states responsible for the quadratic dependence of the laser power, the S_1 and T_1 states of MBP, biradical, and two enols. The participation of the S_1 and T_1 states of MBP in the reaction would be neglected in comparison with benzophenone. Benzophenone also exhibited a two-photon absorption event with the 308-nm laser excitation to dissociate into two phenyl radicals and a carbon monoxide in the T_n state prepared by the $T_n - T_1$ absorption.⁴²⁻⁴⁴ In case of MBP the photoproduct disappeared as time passed to reproduce the parent molecule under the deaerated condition. Therefore, the appropriate photoreactive species would be the biradical and/or the enols. Ullman and Huffman reported that DHA was formed in a photolysis of the enol and a trace of anthrone was an oxidation product of the enol.³ Nakayama et al. measured phosphorescence and its excitation spectra after steady-state photolysis of MBP or E-enol in the rigid matrix at 77 K, and also proposed that DHA should be produced through the excited E-enol.²⁶ Our experimental results with the stepwise two-color transient absorption measurements strongly suggest that the E-enol should be responsible for the reaction. Furthermore, the difference on the reactivity of the two enols, namely, reactive E-enol and unreactive Z-enol, would be consistent with the cyclization reaction to form DHA, whose structure is similar to that of the E-enol. The proper structures of the E-enol and DHA are shown in Scheme 1. It is well-known that irradiation of stilbene and its related compounds results in cis-trans isomerization and cyclic ring closure reaction.⁴⁶ Only cis-stilbene in the S_1 state gives rise to photocyclization reaction to form dihydrophenanthrene. Since the cyclic reactions do not occur in the T_1 state, only cis-trans isomerization is observed. The biradical state was proposed to be a triplet state of the enols.^{15,20,21} Hence, it is concluded that one of the most appropriate candidates for the two-photon absorption reaction of 308 nm would be the E-enol.

SCHEME 1

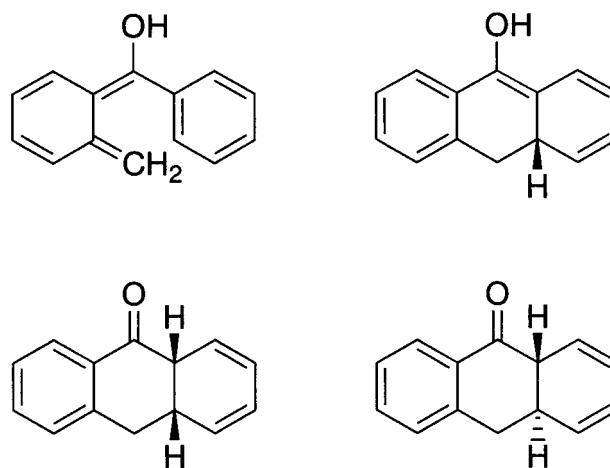

The absorption bands of the enols were observed at less than 540 nm in the UV and visible spectral region. On the two-color excitation transient absorption measurement, the photoreaction of the E-enol was found to occur within an excitation laser pulse even if excited into the edge of the absorption band (532 nm), which is presumably the S_1 state. It reveals that the reaction channel would have been already opened at the bottom of the S_1 state. There is few information on the S_1 state of the E-enol: no fluorescence was observed in an excitation of the E-enol, and the triplet formation was not reported.²⁶ The S_1 potential surface of the E-enol may directly correlate to the reaction coordinate. Furthermore, study of the excitation energy dependence on the cyclization reaction is now in progress.

The heat of reaction from the E-enol to DHA was estimated to be larger than 90 kJ/mol with the TC-TRTL. It is known that photothermal techniques detects not only the thermal energy. The contribution of changes in volume and/or population lens may be included in the lens signal to some extent. The reaction volume change would result from the intrinsic volume change (due to changes in bond lengths and angles) and the volume change associated with the solute-solvent interaction. The intrinsic volume change could be estimated by comparing the van der Waals volume. On the way of increment method proposed by Bondi⁴⁷ the volume change with the cyclization reaction was roughly estimated to be only -2.5 cm³/mol. The intermolecular interaction could contribute to the volume change like keto-enol isomerization.³⁵ However, it seems not to be important on the cyclization reaction because electrostriction change through the reaction should be small. The heat of reaction may be overestimated because of the contribution of population. The sign of population lens would be negative, considering the absorption spectra of the enols and DHA and the Kramers-Kronig relation. Since the spectral range of absorption of E-enol and DHA is similar, the population lens would not affect the lens signal so much. To eliminate the contribution of the population lens the transient grating measurement is under way.

The cyclization reaction includes decrease of one C=C double bond and increase of two C-C single bond. The endothermic reaction would be realized as decrease of length of the conjugated system and distortion of the structure for DHA. However, since DHA is a kind of the enol, the keto-enol tautomerization may occur. The proper structures for the isomers are also illustrated in Scheme 1. Nakayama et al. also pointed out the DHA isomer.²⁶ The isomers presented would have a shorter length of the conjugated system than DHA, and be further distorted. Thus, the absorption spectra were considered

to be blue-shifted and similar to acetophenone and benzaldehyde, which has absorption band at less than 350 nm. Therefore, the most appropriate photoproduct whose color was yellowish would be concluded to be DHA.

Summary

Reaction dynamics in the excited states of two kinds of Z- and E-enols for MBP was investigated in ethanol solution with the TC-TRTL and the stepwise two-color excitation transient absorption techniques. It has been elucidated that only the E-enol does react after the 532-nm laser excitation. The heat of reaction was successfully determined with the TC-TRTL method to be larger than 90 kJ/mol. There was no reactivity for the Z-enol observed. The difference on the reactivity of two enols means the photocyclization reaction would occur on the analogy of stilbene. The candidates for the reaction product were considered to be DHA and/or its isomers.

References and Notes

- (1) Sammes, P. G. *Tetrahedron* **1976**, *32*, 405, references are therein.
- (2) Zwicker, E. F.; Grossweiner, L. I.; Yang, N. C. *J. Am. Chem. Soc.* **1963**, *85*, 2671.
- (3) Ullman, E. F.; Huffman, K. R. *Tetrahedron Lett.* **1965**, 1863.
- (4) Porter, G.; Tchir, M. F. *Chem. Commun.* **1970**, 1372.
- (5) Porter, G.; Tchir, M. F. *J. Chem. Soc. A* **1971**, 3772.
- (6) Findlay, D. M.; Tchir, M. F. *J. Chem. Soc., Faraday Trans. 1* **1976**, *72*, 1096.
- (7) Lutz, H.; Breheret, E.; Lindqvist, L. *J. Chem. Soc., Faraday Trans. 1* **1973**, *60*, 2096.
- (8) Uji-ie, K.; Kikuchi, K.; Kokubun, H. *Chem. Lett.* **1977**, 499.
- (9) Uji-ie, K.; Kikuchi, K.; Kokubun, H. *J. Photochem.* **1979**, *10*, 145.
- (10) Wagner, P. J.; Chen, C.-P. *J. Am. Chem. Soc.* **1976**, *98*, 239.
- (11) Wagner, P. J. *Pure Appl. Chem.* **1977**, *49*, 259.
- (12) Haag, R.; Wirz, J.; Wagner, P. J. *Helv. Chem. Acta* **1977**, *60*, 2595.
- (13) Kitaura, Y.; Matsuura, T. *Tetrahedron* **1969**, *25*, 4487.
- (14) Kitaura, Y.; Matsuura, T. *Tetrahedron* **1971**, *27*, 1597.
- (15) Small, R. D.; Scaiano, J. C. *J. Phys. Chem.* **1977**, *81*, 828.
- (16) Das, P. K.; Encinas, M. V.; Small, R. D., Jr.; Scaiano, J. C. *J. Am. Chem. Soc.* **1979**, *101*, 6965.
- (17) Das, P. K.; Scaiano, J. C. *J. Photochem.* **1980**, *12*, 85.
- (18) Scaiano, J. C. *Chem. Phys. Lett.* **1980**, *73*, 319.
- (19) Encinas, M. V.; Scaiano, J. C. *J. Am. Chem. Soc.* **1981**, *103*, 6397.
- (20) Scaiano, J. C. *Acc. Chem. Res.* **1982**, *15*, 252.
- (21) Scaiano, J. C. *Tetrahedron* **1982**, *38*, 819.
- (22) Johnston, L. J.; Scaiano, J. C. *Chem. Rev.* **1989**, *89*, 521.
- (23) Garcia-Garibay, M. A.; Gamarnik, A.; Bise, R.; Pang, L.; Jenks, W. S. *J. Am. Chem. Soc.* **1995**, *117*, 10264.
- (24) Garcia-Garibay, M. A.; Jenks, W. S.; Pang, L. *J. Photochem. Photobiol. A: Chemistry* **1996**, *96*, 51.
- (25) Nakayama, T.; Hamanoue, K.; Hidaka, T.; Okamoto, M.; Teranishi, H. *J. Photochem.* **1984**, *24*, 71.
- (26) Nakayama, T.; Torii, Y.; Nagahara, T.; Hamanoue, K. *J. Photochem. Photobiol. A: Chemistry* **1998**, *119*, 1.
- (27) Lunazzi, L.; Ticca, A.; Macciantelli, D.; Spunta, G. *J. Chem. Soc., Perkin II* **1976**, 1121.
- (28) Schaefer, T.; Salman, S. R.; Wildman, T. A. *Can. J. Chem.* **1980**, *58*, 2364.
- (29) Akiyama, K.; Ikegami, Y.; Tero-Kubota, S. *J. Am. Chem. Soc.* **1987**, *109*, 2538.
- (30) Ikoma, T.; Akiyama, K.; Tero-Kubota, S.; Ikegami, Y. *J. Phys. Chem.* **1989**, *93*, 7087.
- (31) Jin, P.; Wildman, T. A. *J. Phys. Chem.* **1991**, *95*, 20.
- (32) Yamamoto, S.; Ebata, T.; Ito, M. *J. Phys. Chem.* **1990**, *94*, 5786.
- (33) Suzuki, T.; Okuyama, U.; Ichimura, T. *Chem. Phys. Lett.* **1997**, *266*, 107.
- (34) Omori, T.; Suzuki, T.; Ichimura, T. *Chem. Phys. Lett.* **1998**, *293*, 436.
- (35) Terazima, M. *J. Phys. Chem. A* **1998**, *102*, 545.
- (36) Suzuki, T.; Okuyama, U.; Omori, T.; Ichimura, T. In preparation.
- (37) Braslavsky, S. E.; Heihoff, K. *Handbook of Organic Photochemistry*; CRC Press: Boca Raton, FL, 1988.
- (38) Birks, J. B. *Photophysics of Aromatic Molecules*; Wiley-Interscience: London, 1970.
- (39) Terazima, M.; Azumi, T. *Appl. Phys. Lett.* **1989**, *54*, 2398.
- (40) Terazima, M.; Azumi, T. *J. Phys. Chem.* **1990**, *94*, 4775.
- (41) Suzuki, T.; Kajii, Y.; Shibuya, K.; Obi, K. *Chem. Phys.* **1992**, *161*, 447.
- (42) Kajii, Y.; Suzuki, T.; Takatori, Y.; Shibuya, K.; Obi, K. *Bull. Chem. Soc. Jpn.* **1992**, *65*, 1349.
- (43) Takatori, Y.; Suzuki, T.; Kajii, Y.; Shibuya, K.; Obi, K. *Chem. Phys.* **1993**, *169*, 291.
- (44) Takatori, Y.; Kajii, Y.; Shibuya, K.; Obi, K. *Chem. Phys.* **1994**, *180*, 99.
- (45) Takeda, K.; Kajii, Y.; Shibuya, K.; Obi, K. *J. Photochem. Photobiol. A: Chemistry* **1998**, *115*, 109.
- (46) Turro, N. J. *Modern Molecular Photochemistry*; University Science Books: California, 1991.
- (47) Bondi, A. *J. Phys. Chem.* **1964**, *68*, 441.